

**In/Outputs**

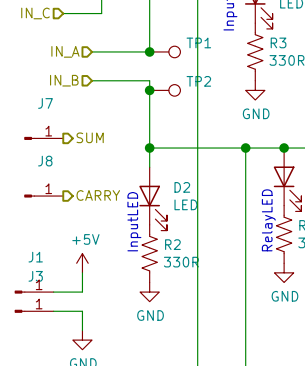

**Power LED**

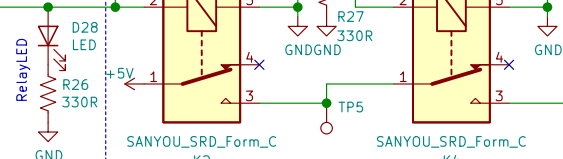

**Power Testpoints**

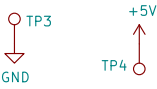

**Optional PullDowns for Inputs**

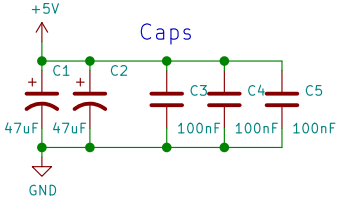
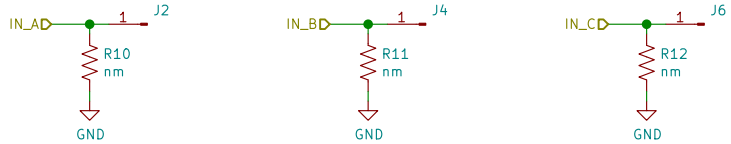

**Mounting**

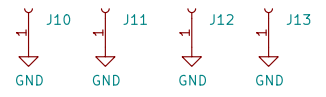

**Backlight**

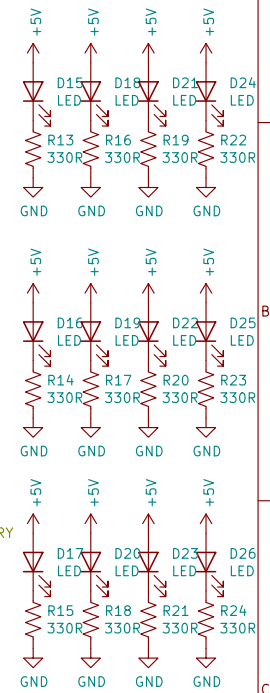

Maximilian Noppel	
<b>nopx industries</b>	
Sheet: /	
File: 1BitFullAdder.sch	
<b>Title: 1BitFullAdder</b>	
Size: A4	Date: 2020-02-27
KiCad E.D.A. kicad 5.1.5-52549c584ubuntu18.04.1	
<b>Rev: 1</b>	
Id: 1/1	